

Low-Cost 16-Pin Frequency Generator

General Description

The **AV9154A** is a 0.8mm version of the industry leading AV9154. Like the AV9154, the **AV9154A** is a low-cost frequency generator designed for general purpose PC and disk drive applications. However, because the **AV9154A** uses 0.8mm technology and the latest phase-locked loop architecture, it offers performance advantages that enable the device to be sold into Pentium™ systems.

The AV9154A guarantees a 45/55 duty cycle over all frequencies. In addition, a worst case jitter of ± 250 ps is specified at Pentium frequencies.

The CPU clock offers the unique feature of smooth, glitch-free transitions from one frequency to the next, making this the ideal device to use when slowing the CPU speed. The **AV9154A** makes a gradual transition between frequencies so that it obeys the Intel cycle-to-cycle timing specifications for 486 and Pentium systems.

The **AV9154A-42** and **AV9154A-43** devices offer features specifically for green PCs. The **AV9154A-42** and **-43** have a single pin that, when pulled low, will smoothly slow the 2XCPU clock to 8 MHz. This is ideal for dynamic DX microprocessors. The **AV9154A-43** not only has the slow clock feature, but also offers a glitch-free stop clock for static SX microprocessors. The STOPCLK# pin, when pulled low, enables the 2XCPU clock to go low only after completing its last full cycle. The clock continues to run internally, and will be output again on the first full cycle immediately following stop clock disable.

The simultaneous 2X and 1X CPU clocks offer controlled skew to within 500ps of each other (-42 only).

ICS has been shipping motherboard frequency generators since April 1990, and is the leader in the area of multiple output clocks on a single chip. Consult ICS for all your clock generation needs.

Features

- Compatible with 386, 486 and Pentium CPUs
- 45/55 Duty cycle
- Runs up to 66 MHz at 3.3V
- Single pin can slow clock to 8 MHz (on -42 and -43)
- Single pin can stop the CPU clock glitch-free (on -43)
- Very low jitter, ± 250 ps for Pentium frequencies
- 1X and 2X CPU clocks skew controlled to ± 250 ps (-42 only)
- Smooth transitions between all CPU frequencies
- Slow frequency ramp at power-on avoids CPU lock-up
- 16-pin PDIP or 150-mil skinny SOIC packages
- 0.8 μ m CMOS technology

Applications

Computer motherboards: The **AV9154A-ST** replaces crystals and oscillators, saving board space, component cost, part count and inventory costs. It produces a switchable CPU clock and up to four fixed clocks to drive floppy disk, communications, super I/O, Bus, and/or keyboard devices. The small package and 3.3V operation is perfect for handheld computers.

Block Diagram

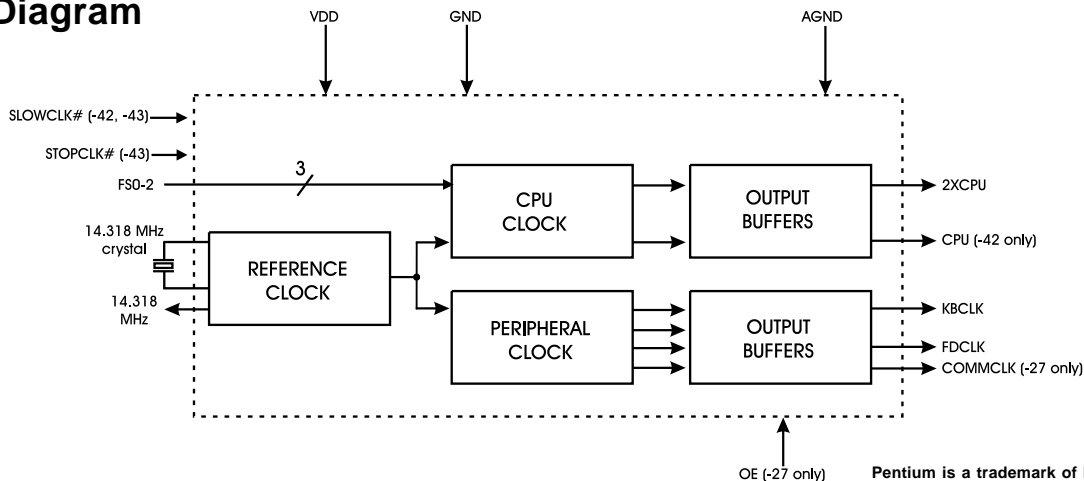



AV9154A

Pin Configuration

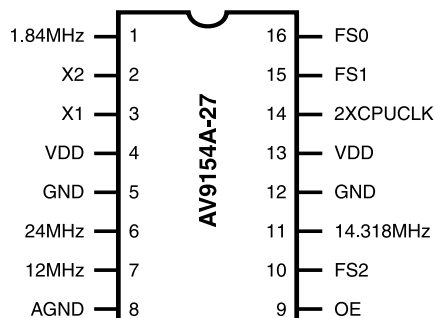

**16-Pin PDIP or SOIC
AV9154A-27**

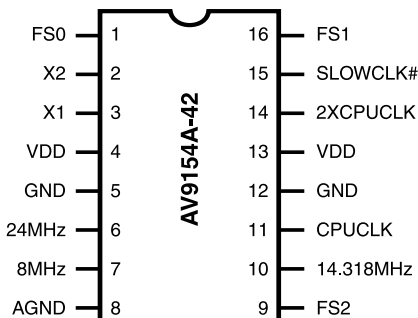

**16-Pin PDIP or SOIC
AV9154A-42**

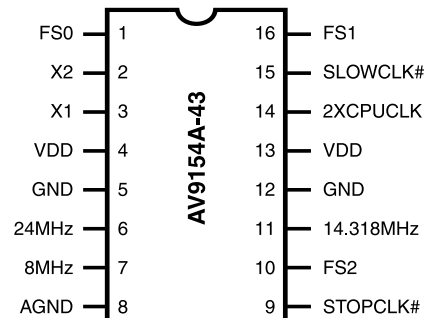

**16-Pin PDIP or SOIC
AV9154A-43**

Description of new pin:

SLOWCLK# forces 2XCPUCLK output to ramp smoothly to 8MHz and CPUCLK output to 4 MHz when pulled low.

Description of new pin:

SLOWCLK# forces 2XCPUCLK output to ramp smoothly to 8MHz when pulled low. STOPCLK# provides glitch-free stop of the 2XCPUCLK output when pulled low. When raised back high, the 2XCPUCLK output clock resumes full speed operation (no clock frequency ramp up since the internal VCO is not stopped).

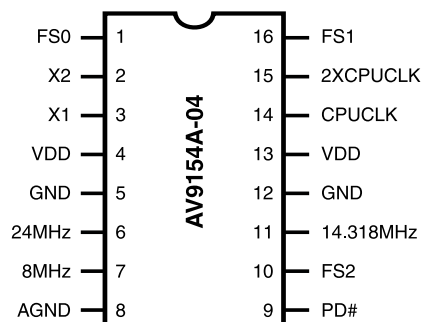

**16-Pin PDIP or SOIC
9154-04**

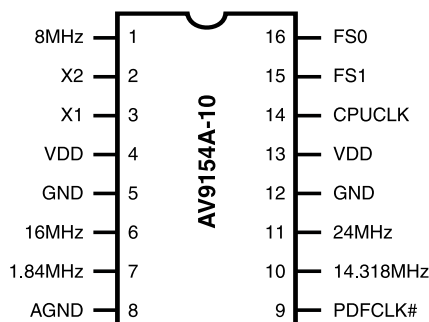

**16-Pin PDIP or SOIC
9154-10**

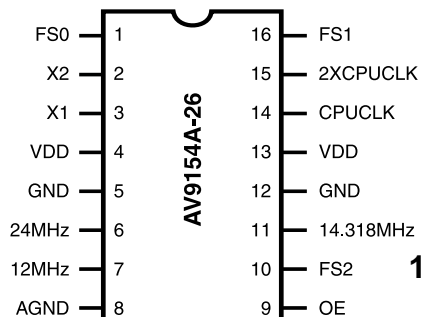

**16-Pin PDIP or SOIC
9154-26**

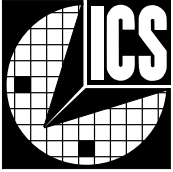

Stop Clock Feature

The ICS9154A-43 incorporates a unique stop clock feature compatible with static logic processors. When the stop clock pin goes low, the 2XCPUCLK will go low after the next occurring falling edge. When STOPCLK again goes high, 2XCPUCLK resumes on the next rising edge of the internal clock. This feature enables fast, glitch-free starts and stops of the 2XCPUCLK and is guaranteed that the CPU does not receive any short period clocks.

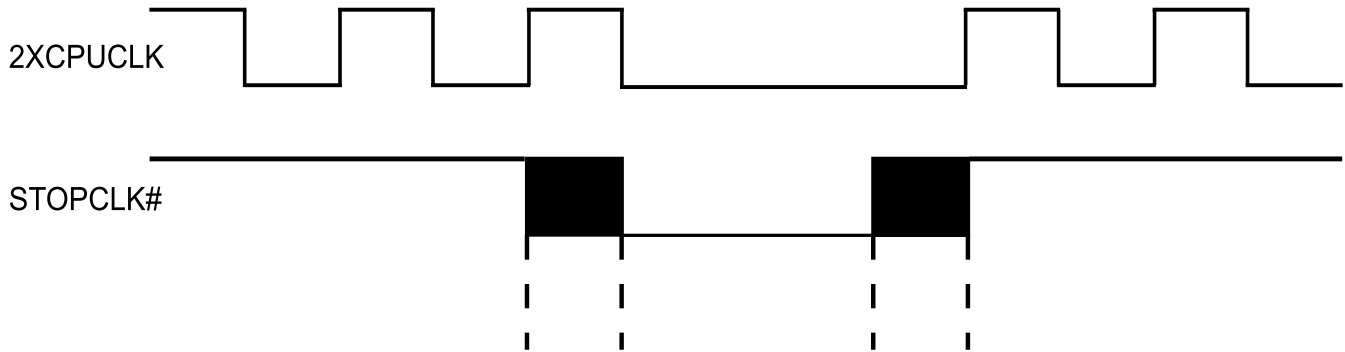

AV9154A



Pin Descriptions

Frequencies based upon 14.318 MHz input)

PIN NUMBER						PIN NAME	TYPE	DESCRIPTION
-4	-10	-26	-27	-42	-43			
4	4	4	4	4	4	VDD	P	Digital power (3.3 or 5V).
13	13	13	13	13	13	VDD	P	Digital power (3.3 or 5V).
5	5	5	5	5	5	GND	P	Digital ground.
12	12	12	12	12	12	GDD	P	Digital ground.
8	8	8	8	8	8	AGND	P	Analog ground.
1	16	1	16	1	1	FS0	I	Frequency select 0 for CPU clock (has internal pull-up).*
16	15	16	15	16	16	FS1	I	Frequency select 1 for CPU clock (has internal pull-up).*
10	-	10	10	9	10	FS2	I	Frequency select 2 for CPU clock (has internal pull-up).*
-	-	9	9	-	-	OE	I	Tristates outputs when low (has internal pull-up).*
-	-	-	-	15	15	SLOWCLK#	I	Slows 2XCPU clock to 8 MHz (active low) (has internal pull-up).
-	-	-	-	-	9	STOPCLK#	I	Stops 2XCPU clock glitch-free (active low) (has internal pull-up).
3	3	3	3	3	3	X1	I	Crystal In.
2	2	2	2	2	2	X2	O	Crystal Out.
11	10	11	11	10	11	14.318 MHz	O	14.318 MHz reference clock output.
-	7	-	1	-	-	1.84 MHz	O	1.84 MHz (comm) clock output.
6	11	6	6	6	6	24 MHz	O	24 MHz (floppy disk) clock output.
-	6	-	-	-	-	16 MHz	O	16 MHz clock output.
-	-	7	7	-	-	12 MHz	O	12 MHz keyboard clock output.
7	1	-	-	7	7	8 MHz	O	8 MHz keyboard clock output.
14	14	14	-	11	-	CPUCLK	O	CPU clock output.
15	-	15	14	14	14	2XCPUCLK	O	2X CPU clock output.
9	-	-	-	-	-	PD#	I	Power-Down All (active low) (has internal pull-up).
-	9	-	-	-	-	PDFCLK#	I	Power-Down Fixed Clock (1.84, 8, 16, 24) (active low).**

Note:

Internal Pull-up Resistors.

* -04 and -10 have no pull-ups or frequency select pins

** -10 has no pull-up or Pin 9 PDFCLK

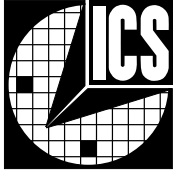

Clock Tables (using 14.318 MHz input, all frequencies in MHz)						
FS2	FS1	FS0	-27 2XCPUCLK	-42		-43 2XCPUCLK
				2XCPUCLK	CPUCLK	^
0	0	0	75*	16	8	16
0	0	1	32	40	20	40
0	1	0	60	33.33	16.67	33.33
0	1	1	40	25	12.50	25
1	0	0	50	60	30	60
1	0	1	66.66	20	10	20
1	1	0	80*	66.66	33.33	66.66
1	1	1	52	50	25	50

Actual Frequencies (using 14.318 MHz input, all frequencies in MHz)						
FS2	FS1	FS0	-27 2CPUCLK	-42		-43
				2XCPUCLK	CPUCLK	2XCPUCLK
0	0	0	75.17*	16.00	8.00	16.00
0	0	1	31.94	40.09	20.05	40.09
0	1	0	60.14	33.41	16.71	33.41
0	1	1	40.09	25.06	12.55	25.06
1	0	0	50.11	60.14	30.07	60.14
1	0	1	66.48	20.05	10.03	20.05
1	1	0	80.18*	66.48	33.24	66.48
1	1	1	51.90	50.11	25.06	50.11

Fixed Clock Output Actual Frequencies (using 14.318 MHz input, all frequencies in MHz)
14.318
1.84
24.0
12.0
8.0

Clock Tables in MHz for -04 and -10 (using 14.318 MHz input , all frequencies in MHz)			
FS(3:0)	-04		-10
	2XCPU	CPU	CPUCL- K
0	100*	50*	PDCPU
1	80*	40*	40
2	66.6	33.3	50
3	50	25	66.6
4	40	20	-
5	32	16	-
6	24	12	-
7	16	8	-
-			

Clock Table for AV9154A-26 (using 14.318 MHz input all frequencies in MHz)		
FS(2:0)	2XCPU (MHz)	CPUCLK (MHz)
0	100.23*	50.11
1	80.18*	40.09
2	66.48*	33.24
3	50.11	25.06
4	40.09	20.05
5	32.22	16.11
6	24.23	12.12
7	15.75	7.88

* These selections only operate at 5 V.



AV9154A

Absolute Maximum Ratings

V_{DD} referenced to GND 7.0 V
 Voltage on I/O pins referenced to GND GND - 0.5 V to VDD + 0.5 V
 Operating Temperature under bias 0 to +70 °C
 Power Dissipation 0.5 W
 Storage Temperature -40 to +150 °C

Stresses above those listed under *Absolute Maximum Ratings* may cause permanent damage to the device. These ratings are stress specifications only and functional operation of the device at these or any other conditions above those listed in the operational sections of the specifications is not implied. Exposure to absolute maximum rating conditions for extended periods may affect product reliability.

Electrical Characteristics at 3.3 V

V_{DD} = 3.3 V ± 10%, T_A = 0 - 70 °C unless otherwise stated

DC Characteristics						
PARAMETER	SYMBOL	TEST CONDITIONS	MIN	TYP	MAX	UNITS
Input Low Voltage	VIL		-	-	0.2 VDD	V
Input High Voltage	VIH		0.7 V	-	-	V
Input Low Current	IIL	VIN = 0V (pull-up pin)	-	2.5	7.0	A
Input High Current	IIH	V _{IN} = VDD	-5.0	-	5.0	A
Output Low Voltage	VOL	IOL = 6mA	-	0.05 VDD	0.1 VDD	V
Output High Voltage ¹	VOH	IOH = -4mA	0.85 VDD	0.94 VDD	-	V
Output Low Current ¹	IOL	VOL = 0.2VDD	15.0	24	-	mA
Output High Current ¹	IOH	VOH = 0.7VDD	-	-13	-8.0	mA
Supply Current	IDD	unloaded, 60 MHz	-	16	34	mA
Output Frequency Change over Supply and Temperature ¹	FD	With respect to typical frequency	-	0.002	0.01	%
Short circuit current ¹	ISC	each output clock	20	30	-	mA
Input Capacitance ¹	CI	except X1, X2	-	-	10	pF
Load Capacitance ¹	CL	pins X1, X2	-	20	-	pF
Pull-up Resistor ¹	Rpu	at VDD - 0.5V	-	620	900	k ohm

Notes:

1. Parameter is guaranteed by design and characterization.

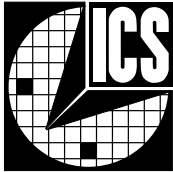
**Electrical Characteristics at 3.3 V** $V_{DD} = 3.3\text{ V} \pm 10\%$, $T_A = 0 - 70\text{ }^\circ\text{C}$ unless otherwise stated

AC Characteristics						
PARAMETER	SYMBOL	TEST CONDITIONS	MIN	TYP	MAX	UNITS
Input Clock Rise Time ¹	t _{icr}		-	-	20	ns
Input Clock Fall Time ¹	t _{icf}		-	-	20	ns
Rise time, 20% to 80% V_{DD} ¹	t _r	15pF load	-	2.2	3.5	ns
Fall time, 80% to 20% V_{DD} ¹	t _f	15pF load	-	1.2	2.5	ns
Duty cycle at 50% V_{DD} ¹	dt	15pF load	40/60	48/52	60/40	%
Duty cycle, reference clocks ¹	dt	15pF load	50/65	43/57	65/50	%
Jitter, one sigma, 20-66 MHz clocks ¹	t _{j1s}	10,000 cycles	-	100	200	ps
Jitter, one sigma, clocks below 20 MHz ¹	t _{j1s}	10,000 cycles	-	1.0	2.0	%
Jitter, absolute, 20-66 MHz clocks ¹	t _{jab}	10,000 cycles	-350	-	350	ps
Jitter, absolute, clocks below 20 MHz ¹	t _{jab}	10,000 cycles	-	1.5	4.0	%
Input Frequency ¹	f _{in}		2	14.318	32	MHz
Maximum Output Frequency ¹	f _{out}		70	-	-	MHz
Clock skew between CPU and 2XCPU outputs ¹	T _{sk}	AV9154A-42	-	220	500	ps
Power-up Time ¹	t _{PO}	off to 50 MHz	-	6	12	ms
Frequency Transition Time ¹	t _{ft}	from 8 to 50 MHz	-	4.5	10	ms

Notes:

1. Parameter is guaranteed by design and characterization. Not subject to production testing.



Electrical Characteristics at 5.0V

$V_{DD} = +5 \pm 10\% \text{ V}$, $T_A = 0 - 70^\circ\text{C}$ unless otherwise stated

DC Characteristics						
PARAMETER	SYMBOL	TEST CONDITIONS	MIN	TYP	MAX	UNITS
Input Low Voltage	V_{IL}	$V_{DD}=5 \text{ V}$	-	-	0.8	V
Input High Voltage	V_{IH}	$V_{DD}=5 \text{ V}$	2.0	-	-	V
Input Low Current	I_{IL}	$V_{IN}=0 \text{ V}$ (pull-up pin)	-	6	15	A
Input High Current	I_{IH}	$V_{IN} = V_{DD}$	-5	-	5	A
Output Low Voltage	V_{OL}	$I_{OL} = 10 \text{ mA}$	-	0.15	0.4	V
Output High Voltage ¹	V_{OH}	$I_{OH} = -30 \text{ mA}$	2.4	3.7	-	V
Output Low Current ¹	I_{OL}	$V_{OL} = 0.8 \text{ V}$	25	45	-	mA
Output High Current ¹	I_{OH}	$V_{OH} = 2.4 \text{ V}$	-	-53	-35	mA
Supply Current	I_{DD}	unloaded, 66 MHz	-	25	50	mA
Output Frequency Change over Supply and Temperature ¹	F_D	with respect to typical frequency	-	0.002	0.01	%
Short circuit current ¹	I_{SC}	each output clock	25	40	-	mA
Input Capacitance ¹	C_I	except X1, X2	-	-	10	pF
Load Capacitance ¹	C_L	pins X1, X2	-	20	-	pF
Pull-up Resistor ¹	R_{pu}	$A + V_{DD} - 1 \text{ V}$	-	400	700	k ohm

Notes:

1. Parameter is guaranteed by design and characterization. Not subject to production testing.

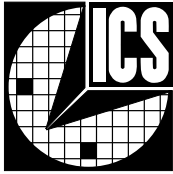

Electrical Characteristics at 5.0V

V_{DD} = +5 ±10% V, T_A = 0 - 70°C unless otherwise stated

AC Characteristics						
PARAMETER	SYMBOL	TEST CONDITIONS	MIN	TYP	MAX	UNITS
Input Clock Rise Time ¹	t _{ICr}		-	-	20	ns
Input Clock Fall Time ¹	t _{ICf}		-	-	20	ns
Output Rise time, 0.8 to 2.0V ¹	t _r	15pF load	-	1.5	2	ns
Rise time, 20% to 80% V ¹	t _r	15pF load	-	2.0	3	ns
Output Fall time, 2.0 to 0.8V ¹	t _f	15pF load	-	0.5	1.5	ns
Fall time, 80% to 20% V ¹	t _f	15pF load	-	2.0	3.0	ns
Duty cycle at 1.4V ¹	dt	15pF load, V _{DD} = 5V±5%	45/55	48/52	55/45	%
Duty cycle, reference clocks ¹	dt	15 pF load	40/65	43/57	65/40	%
Jitter, one sigma, 20 MHz-80 MHz clocks ¹	t _{jls}	10,000 cycles	-	70	140	ps
Jitter, one sigma, clocks below 20 MHz ¹	t _{jls}	10,000 cycles	-	0.8	2.0	%
Jitter, absolute, 20 MHz-80 MHz clocks ¹	t _{jab}	10,000 cycles	-250	-	250	ps
Jitter, absolute, clocks below 20 MHz ¹	t _{jab}	10,000 cycles	-	1.0	3.0	%
Input Frequency	f _{in}		2	14.318	32	MHz
Maximum Output Frequency ¹	f _{out}		140	-	-	MHz
Clock skew between CPU and 2XCPU outputs ¹	T _{sk}	AV9154A-42	-	140	400	ps
Power-up Time ¹	t _{PO}	to 80 MHz	-	8	15	ms
Frequency Transition Time ¹	t _{ft}	from 8 to 66.66 MHz	-	6.5	12	ms

Notes:

1. Parameter is guaranteed by design and characterization. Not subject to production testing.

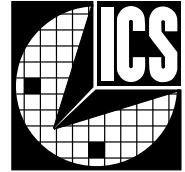

AV9154A

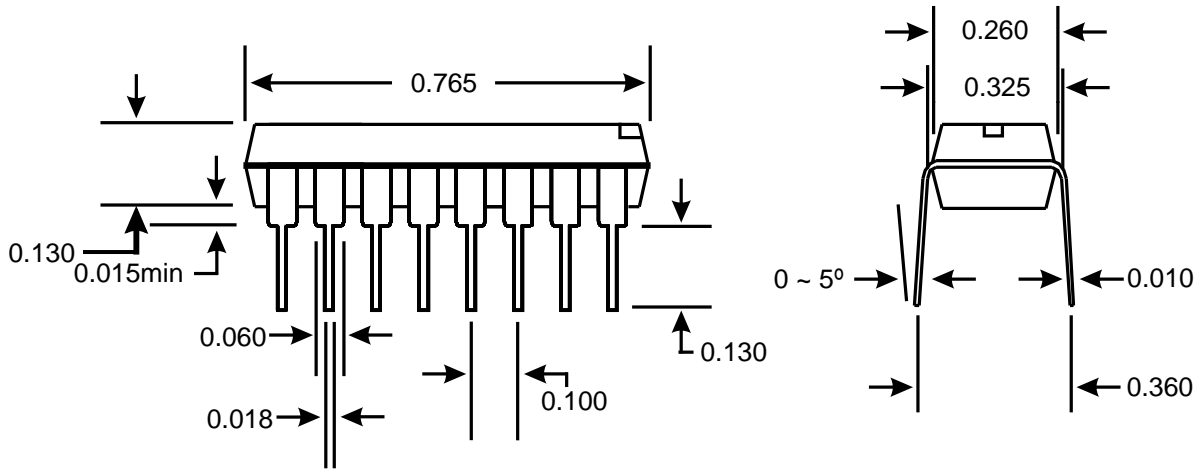

16-Pin PDIP Package

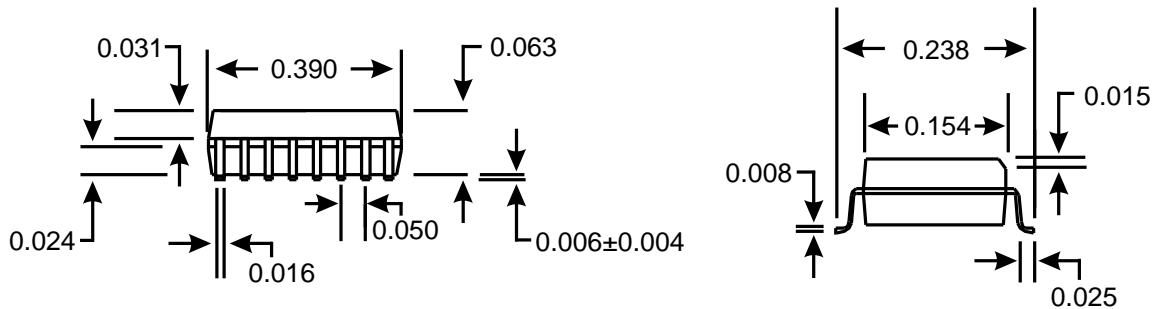

16-Pin SOIC Package

Ordering Information

AV9154A-04CN16	AV9154A-27CN16	AV9154A-04CS16	AV9154A-27CS16
AV9154A-10CN16	AV9154A-42CN16	AV9154A-10CS16	AV9154A-42CS16
AV9154A-26CN16	AV9154A-43CN16	AV9154A-26CS16	AV9154A-43CS16

Example:

ICS XXXX-PPP M X#W

